

# EXPANSION CLIP TOPS



## 2" EXPANSION CLIP TOP 3/4" WIDE TOP

Our standard 2" expansion clip top fits a wide variety of panels with it's 3/4" wide top.

Use with our 5" expansion clip bases.

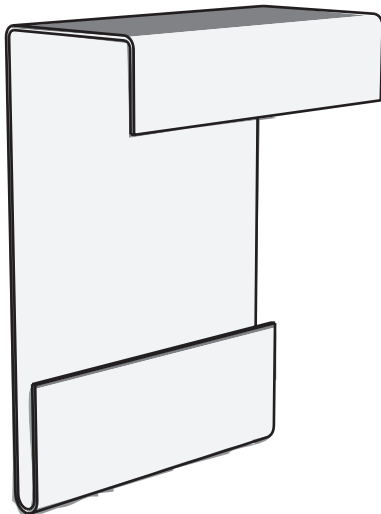

### 2" EXPANSION CLIP TOP 3/4" WIDE GALV.

| Part Number | Description                    | Box Qty | Price Each |
|-------------|--------------------------------|---------|------------|
| 200-ST-24-G | Expansion Clip Top, 24ga Galv. | 1000    | \$0.14     |
| 200-ST-22-G | Expansion Clip Top, 22ga Galv. | 1000    | \$0.175    |

### 2" EXPANSION CLIP TOP 3/4" WIDE 304 STAINLESS

| Part Number | Description                        | Box Qty | Price Each |
|-------------|------------------------------------|---------|------------|
| 200-ST-24-S | Expansion Clip Top, 24ga Stainless | 1000    | \$0.33     |
| 200-ST-22-S | Expansion Clip Top, 22ga Stainless | 1000    | \$0.37     |

H = 2"  
W = 1-3/4"  
DL = 1/2"  
T = 3/4"

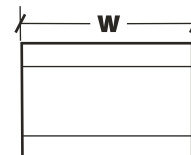
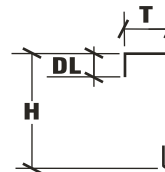

## 2" EXPANSION CLIP TOP 13/16" WIDE TOP

With it's 13/16" wide top, this 2" expansion clip top fits Knudson panels. Also fits others.

Use with our 5" expansion clip bases.

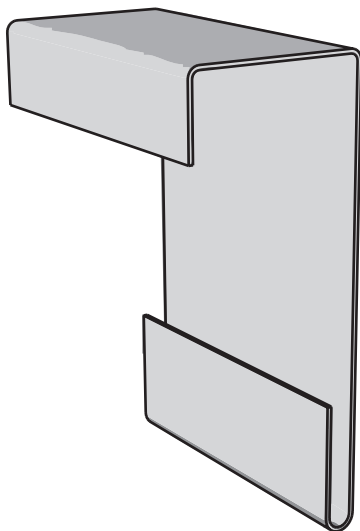

### 2" EXPANSION CLIP TOP 13/16" WIDE for KNUDSON GALV

| Part Number   | Description                    | Box Qty | Price Each |
|---------------|--------------------------------|---------|------------|
| 200-ST-24-G-K | Expansion Clip Top, 24ga Galv. | 1000    | \$0.14     |
| 200-ST-22-G-K | Expansion Clip Top, 22ga Galv. | 1000    | \$0.175    |

### 2" EXPANSION CLIP TOP 13/16" WIDE for KNUDSON 304 STAINLESS

| Part Number   | Description                        | Box Qty | Price Each |
|---------------|------------------------------------|---------|------------|
| 200-ST-24-S-K | Expansion Clip Top, 24ga Stainless | 1000    | \$0.33     |
| 200-ST-22-S-K | Expansion Clip Top, 22ga Stainless | 1000    | \$0.37     |

H = 2"  
W = 1-3/4"  
DL = 1/2"  
T = 13/16"

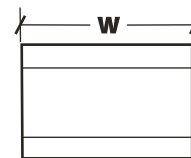
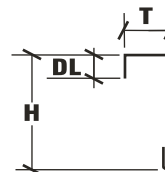

For more info or to place an order call us toll free: **800-943-9771**



# EXPANSION CLIP TOPS

## 2" EXPANSION CLIP TOP 5/8" WIDE TOP

Designed to specifically fit the Quadro-Pro standing seam profile, this clip features a 5/8" wide top. Use with our 5" expansion clip bases.

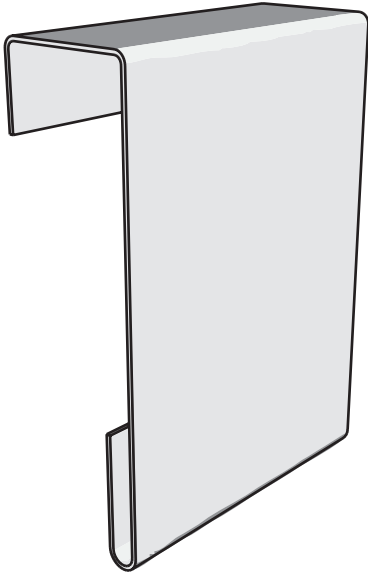

### 2" EXPANSION CLIP TOP 5/8" WIDE for QUADRO-PRO GALV.

| Part Number    | Description                    | Box Qty | Price Each |
|----------------|--------------------------------|---------|------------|
| 200-ST-24-G-QP | Expansion Clip Top, 24ga Galv. | 1000    | \$0.14     |
| 200-ST-22-G-QP | Expansion Clip Top, 22ga Galv. | 1000    | \$0.175    |

### 2" EXPANSION CLIP TOP 5/8" WIDE for QUADRO-PRO304 STAINLESS

| Part Number    | Description                        | Box Qty | Price Each |
|----------------|------------------------------------|---------|------------|
| 200-ST-24-S-QP | Expansion Clip Top, 24ga Stainless | 1000    | \$0.33     |
| 200-ST-22-S-QP | Expansion Clip Top, 22ga Stainless | 1000    | \$0.37     |

H = 2"  
W = 1-3/4"  
DL = 3/8"  
T = 5/8"

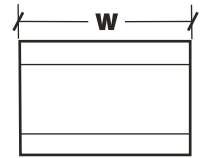
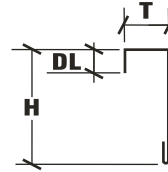

## 2" EXPANSION CLIP TOP 7/16" WIDE TOP

Our 2+50 expansion clip top was originally designed to fit VSR panels, but is great fit for any standard 1 1/2" mechanically seamed roof panel where it is desirable to "lift" the panel. Use with our 5" expansion clip bases.

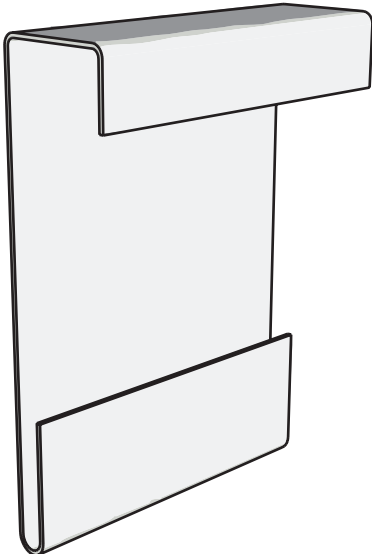

### 2" EXPANSION CLIP TOP 7/16" WIDE GALV

| Part Number  | Description                    | Box Qty | Price Each |
|--------------|--------------------------------|---------|------------|
| 2+50-ST-24-G | Expansion Clip Top, 24ga Galv. | 600     | \$0.14     |
| 2+50-ST-22-G | Expansion Clip Top, 22ga Galv. | 600     | \$0.175    |

### 2" EXPANSION CLIP TOP 7/16" WIDE 304 STAINLESS

| Part Number  | Description                        | Box Qty | Price Each |
|--------------|------------------------------------|---------|------------|
| 2+50-ST-24-S | Expansion Clip Top, 24ga Stainless | 600     | \$0.33     |
| 2+50-ST-22-S | Expansion Clip Top, 22ga Stainless | 600     | \$0.37     |

H = 2"  
W = 1-3/4"  
DL = 5/16"  
T = 7/16"

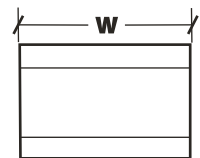
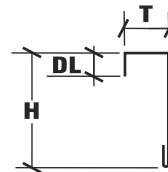

For more info or to place an order call us toll free: **800-943-9771**

# EXPANSION CLIP TOPS



## UL CLASSIFIED 2" EXPANSION CLIP 3/4" WIDE TOP

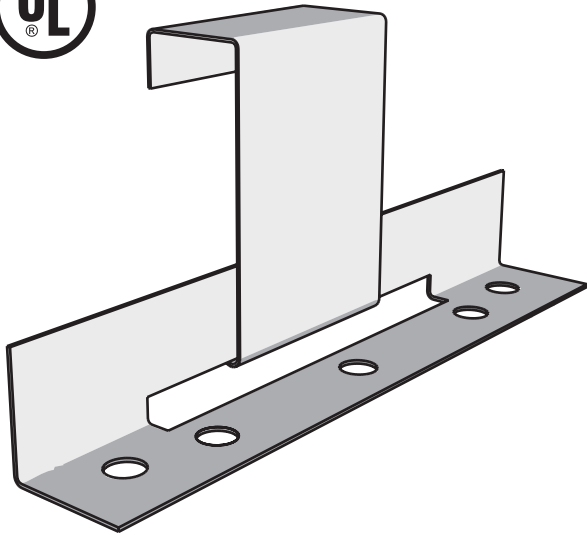

### UL CLASSIFIED 2" EXPANSION CLIP 3/4" TOP GALV.

| Part Number   | Description                                                               | Box Qty | Price Each |
|---------------|---------------------------------------------------------------------------|---------|------------|
| 200-SAE2218-G | UL Classified Expansion Clip Assembly<br>22ga Galv Top w/ 18ga Galv. Base | 500     | \$0.395    |

\*This product cannot be shipped unassembled.

H = 2"  
W = 1-3/4"  
DL = 1/2"  
T = 3/4"

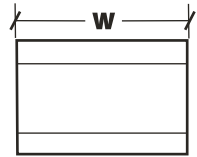
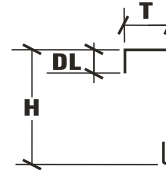

H = 3/4"  
W = 5"  
S = 3"

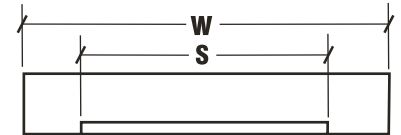

## 2 1/2" EXPANSION CLIP TOP 3/4" WIDE TOP

Our 2 1/2" expansion clip top fits most taller profiles and can be used where additional panel to deck clearance is required.

Use with our 5" expansion clip base.

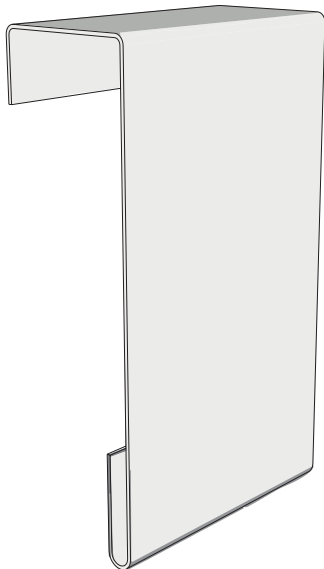

### 2 1/2" EXPANSION CLIP TOP 3/4" WIDE GALV

| Part Number | Description                    | Box Qty | Price Each |
|-------------|--------------------------------|---------|------------|
| 250-ST-24-G | Expansion Clip Top, 24ga Galv. | 750     | \$0.175    |
| 250-ST-22-G | Expansion Clip Top, 22ga Galv. | 750     | \$0.185    |

### 2 1/2" EXPANSION CLIP TOP 3/4" WIDE 304 STAINLESS

| Part Number | Description                        | Box Qty | Price Each |
|-------------|------------------------------------|---------|------------|
| 250-ST-24-S | Expansion Clip Top, 24ga Stainless | 750     | \$0.44     |
| 250-ST-22-S | Expansion Clip Top, 22ga Stainless | 750     | \$0.47     |

H = 2-1/2"  
W = 1-3/4"  
DL = 1/2"  
T = 3/4"

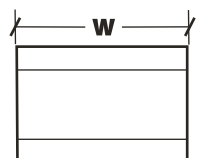
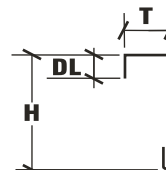

For more info or to place an order call us toll free: **800-943-9771**